

winflex[®]

DG

Tapered grid coupling

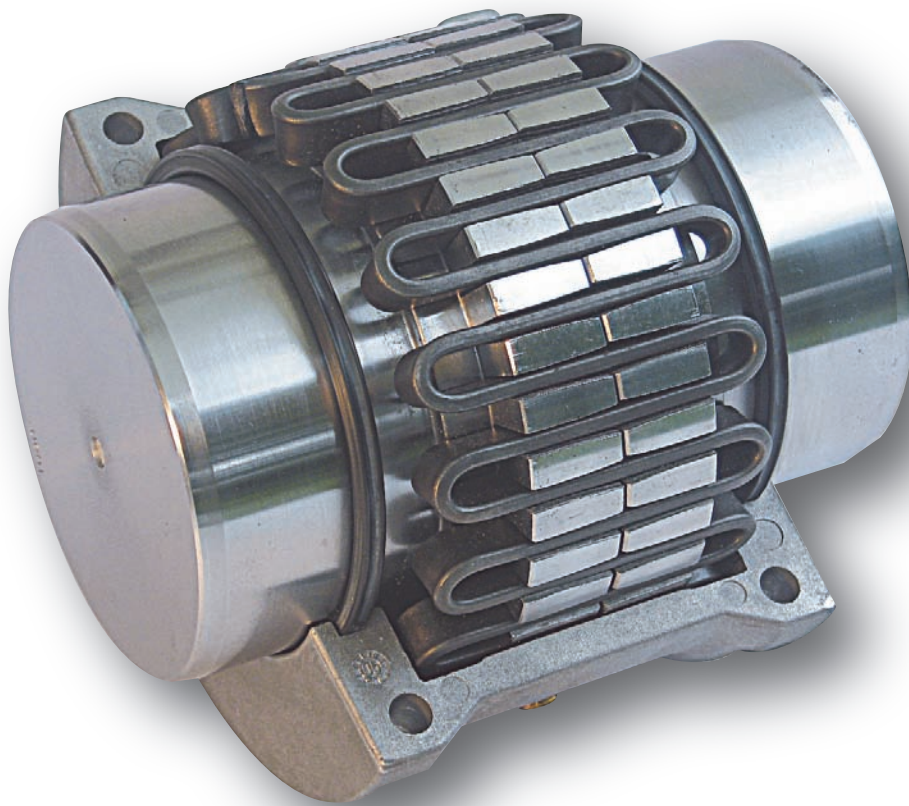

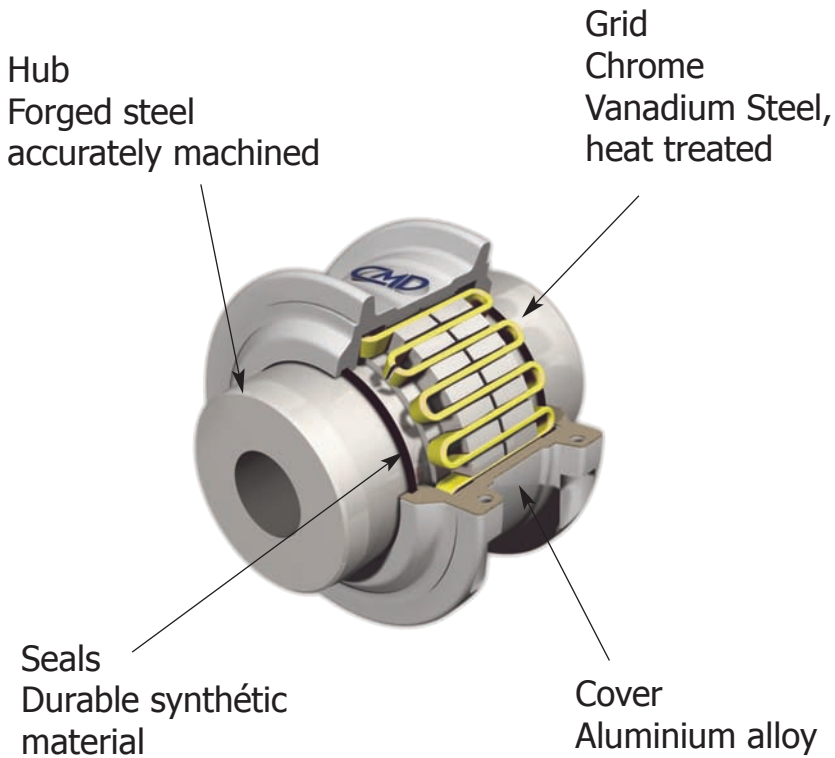

SF Applications*

- 1 Agitators, pumps, centrifugal fans and compressors, even load generators ...
- 1.25 Rotary compressors, buckets conveyors, rotary pumps, elevators ...
- 1.50 Paper industries, rewinders, scrapers, conveyor, mills stand with turbines driven with helical gears ...
- 1.75 Hammer mills, general handling, notching press, press circular resaw, planer, calander, super calander, couch press ...
- 2.00 Small and medium cement kilns, wire mills, calanders with overload generators, edger, log, haul, rolls, harbour and grad-buckets crane, draw bench, wire drawing, straighteners, flattening cane knife, and crushers, fans for cooling tower ...
- 2.50 Rod mills, chippers, ball mills, mixers, external mixers, mills, big kilns, fillers, strips, lingots ...
- 3.00 Feeds rolls, one cyl. Pumps ...

* For information only. Please contact CMD for further details.

Interchangeable chart



FALK

1020 DGH	1020 T 10
1030 DGH	1030 T 10
1040 DGH	1040 T 10
1050 DGH	1050 T 10
1060 DGH	1060 T 10
1070 DGH	1070 T 10
1080 DGH	1080 T 10
1090 DGH	1090 T 10
1100 DGH	1100 T 10
1110 DGH	1110 T 10
1120 DGH	1120 T 10
1130 DGH	1130 T 10
1140 DGH	1140 T 10
1150 DGH	1150 T 10
1160 DGH	1160 T 10
1170 DGH	1170 T 10
1180 DGH	1180 T 10
1190 DGH	1190 T 10
1200 DGH	1200 T 10

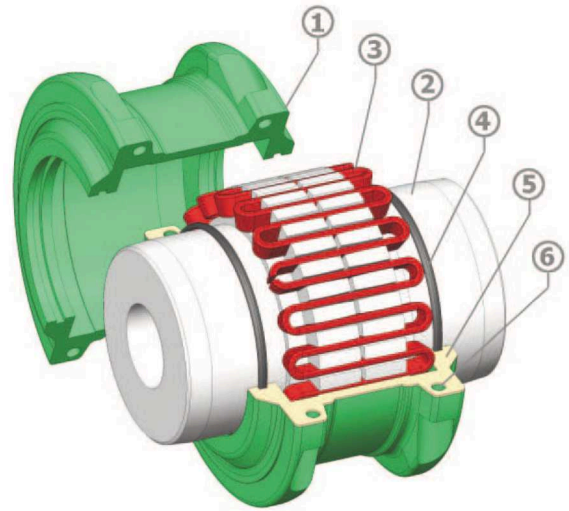
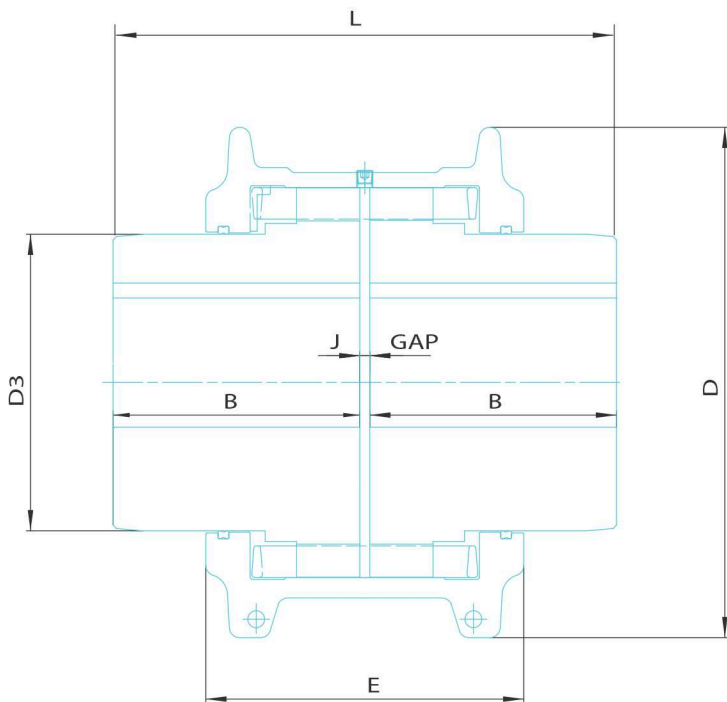

Item	Désignation
1	Cover
2	Hub
3	Grid
4	Seal
5	Gasket
6	Fasteners

Sizes	Torque rating (Nm)	Maximum bore* (mm)	Dimensions						Lube weight (kg)	Coupling weight (kg)	Allow speed (Rpm)
			B	D	D3	E	J	L			
1020 DGH	52	28	47	88	39,5	68	3	97	0,03	1,8	4500
1030 DGH	149	35	47	99	49	70	3	97	0,03	2,4	4500
1040 DGH	249	42	50	107	57	71	3	103	0,06	3,2	4500
1050 DGH	435	50	60	130	66,5	85	3	123	0,06	5,1	4500
1060 DGH	684	56	63	139	76	92	3	129	0,09	7,2	4350
1070 DGH	994	65	76	150	87	95	3	155	0,11	10,1	4125
1080 DGH	2 050	80	88	176	104,5	117	3	179	0,17	17,8	3600
1090 DGH	3 730	95	98	196	123,5	123	3	199	0,25	25	3600
1100 DGH	6 280	110	120	251	142	156	5	245	0,43	43	2440
1110 DGH	9 320	120	127	270	160	162	5	259	0,51	56	2250
1120 DGH	13 700	137	149	308	179	192	6	304	0,74	81,2	2025
1130 DGH	19 900	165	162	346	217	195	6	330	0,91	121	1800
1140 DGH	28 600	184	182	384	254	201	6	374	1,2	178	1650
1150 DGH	39 800	215	182	453	269	271,5	6	372	1,95	234	1500
1160 DGH	55 900	240	198	504	305	278	6	402	2,18	317	1350
1170 DGH	74 600	280	216	567	356	307	6	439	3,49	448	1225
1180 DGH	103 000	300	239	629	394	321	6	484	3,76	619	1110
1190 DGH	137 000	335	259	757	437	355	6	524	4,40	776	1050
1200 DGH	186 000	360	279	845	498	432	6	565	5,62	1058	900

* For rectangular section keys (ISO)
 When severe loading conditions exist be advise to reduce by 10% the table maximum bore capacities for hubs
 • Values are for hubs without bore
 Note: all dimensions are subject to change without notification

Other Products

Flexible couplings



**Flexident Senior
Gear coupling**

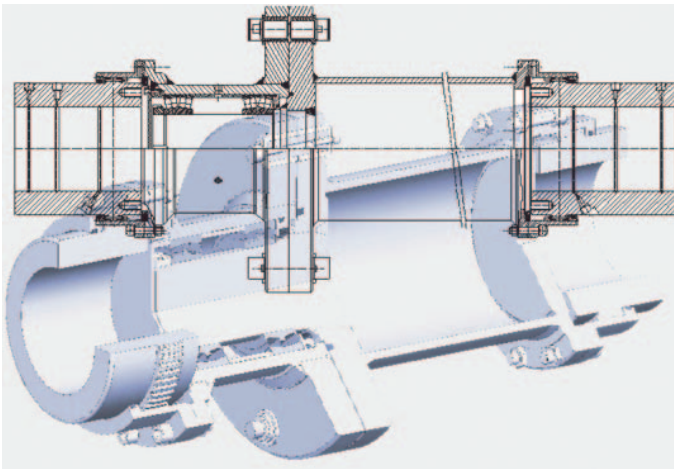

**Customized
coupling**



ISO 9001



SALES DEPARTMENT

36 avenue de l'Europe - Immeuble l'Etendard
BP 43 - 78142 VELIZY Cedex - FRANCE

Phone: +33(0) 1 34 63 12 24 - Fax: +33(0) 1 34 63 12 45
contact@cmdgears.com

HEAD OFFICE - FACTORY

539, avenue du Cateau - 59400 CAMBRAI - FRANCE
Phone: +33(0) 3 27 73 53 11 - Fax: +33(0) 3 27 78 36 99
www.cmd-couplings.com
www.cmd-gears.com